

OPS Module and Display

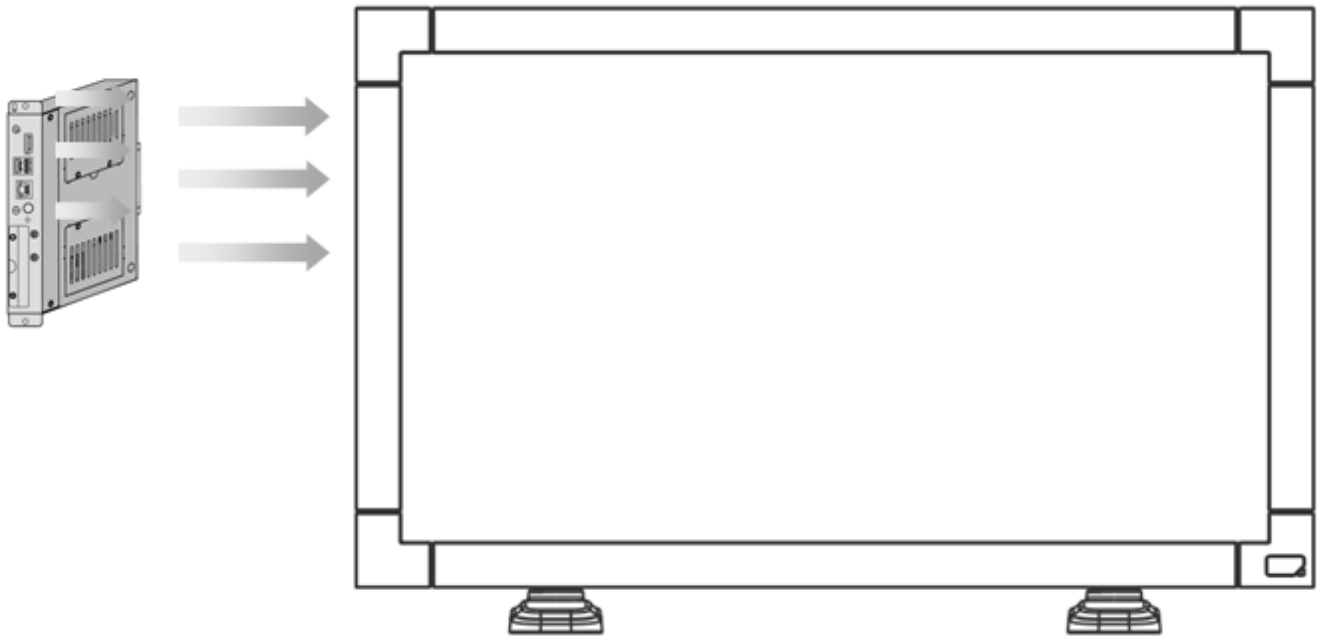

Quick Installation Guide

Version 1.1

Table of Contents

Regulations and Safety Notice	2
CE Declaration of Conformity	2
FCC Notice	2
Advisory Conventions	3
OPS Module and Display Quick Start Guide	4
Important Safety Instructions	4
Cleaning the Monitor	4
Introduction	5
Unpacking	5
Touch and Power Connection Scenario	6
Case I PC Mode	6
Case II Monitor Mode	6
Case III PC Mode	7
OPS Module Installation	8
Display Input Signal Settings	9
Remote Control Layout	9
Display Input Signal Settings	10
Power Management Settings	11
Windows OS	11
Android OS	15

Regulations and Safety Notice

CE Declaration of Conformity

We declare under our responsibility that the product is in conformity with the following standards:

- EN60950-1:2006+A11:2009 (Safety requirement of Information Technology Equipment)
- EN55022:2006+A1:2007 (Radio Disturbance requirement of Information Technology Equipment)
- EN55024:1998+A1:2001+A2:2003 (Immunity requirement of Information Technology Equipment)
- EN61000-3-2:2006 (Limits for Harmonic Current Emission)
- EN61000-3-3:2008 (Limitation of Voltage Fluctuation and Flicker) following provisions of directives applicable
- 2006/95/EC (Low Voltage Directive)
- 2004/108/EC (EMC Directive)
- 2005/32/EC (EuP, Energy-using Product Directive) EC No. 642/2009 Implementing
- 93/68/EEC (Amendment of EMC and Low Voltage Directive) and is produced by a manufacturing organization on ISO9000 level.

FCC Notice



This device complies with part 15 FCC rules.

Operation is subject to the following two conditions:

- This device may not cause harmful interference.
- This device must accept any interference received including interference that may cause undesired operation.

This equipment has been tested and found to comply with the limits for a class "B" digital device, pursuant to part 15 of the FCC rules. These limits are designed to provide reasonable protection against harmful interference when the equipment is operated in a commercial environment. This equipment generates, uses, and can radiate radio frequency energy and, if not installed and used in accordance with the instruction manual, may cause harmful interference to radio communications. Operation of this equipment in a residential area is likely to cause harmful interference in which case the user will be required to correct the interference at his own expense.

Advisory Conventions

Four types of advisories are used throughout the user guide to provide helpful information or to alert you to the potential for hardware damage or personal injury. These are Notes, Important, Cautions, and Warnings. The following is an example of each type of advisory.



NOTE:

A note is used to emphasize helpful information



IMPORTANT:

An important note indicates information that is important for you to know.



CAUTION

A Caution alert indicates potential damage to hardware and explains how to avoid the potential problem.



WARNING!

An Electrical Shock Warning indicates the potential harm from electrical hazards and how to avoid the potential problem.

OPS Module and Display Quick Start Guide

Important Safety Instructions

Please read the following instructions carefully.

1. Unplug the display if you are not going to use it for an extensive period of time.
2. Keep the display out of direct sunlight and away from stoves or any other heat source.
3. Keep the display dry. To avoid electric shock, do not expose it to rain or excessive moisture.
4. When positioning the display, make sure the power plug and outlet are easily accessible.
5. The casing cover should be opened only by qualified service personnel.
6. If turning off the display by detaching power cable or DC power cord, wait for 6 seconds before attach the power cable or DC power cord for normal operation.



IMPORTANT:

Always activate a screen saver program during your application. If still image in high contrast remains on the screen for an extended period of time, it may leave an 'after-image' or 'ghost image' on the front of the screen. This is a well-known phenomenon that is caused by the shortcomings inherent in the LCD technology. In most cases the afterimage will disappear gradually over a period of time after the power has been switched off. Be aware that the after-image symptom cannot be repaired and is not covered under warranty.

Cleaning the Monitor

To clean the display:

- Unplug the display.
- Clean the surface of the screen with a clean, soft, lint-free cloth. This removes dust and other particles. Do not use acetone, ethyl alcohol, toluene, ethyl acid or methyl chloride to clear the panel. It may permanently damage the display screen.
- You can apply a small amount of non-ammonia; non-alcohol based glass cleaner onto a clean, soft, lint-free cloth and wipe the screen.
- Never spray or pour any liquid directly on the screen or case. If droplets are allowed to drop on the screen, permanent staining or discoloration may occur.



CAUTION

Always turn off the device and disconnect other peripherals before cleaning and maintenance procedures.

Introduction

Open Pluggable Specification (OPS) enables easy integration of a digital signage computing system or a pluggable module into the display panel.

This quick start guide tells you step-by-step instruction on how to install OPS module to the display. You will find instructions for the following procedures:

- Unpacking
- Touch and Power Connection Scenario
- OPS Module Installation
- Display Input Signal Settings
- Powering ON/ OFF
- Power Management Settings
- Sealing Surface Acoustic Wave Touch Screen

Unpacking

This product is packed in a carton, together with the standard accessories. Any other optional accessories will be packed separately. Due to the size and weight of this display it is recommended for two people to move it. After opening the carton, ensure that the content is in good condition and complete.

Check if all of the following items are included in your package.

- CD ROM with Drivers (for OPS)
- Remote control with AAA batteries
- Power cord (1.8 m)
- VGA cable (1.8 m)
- Quick Installation Guide
- Power switch cover
- Screw for power switch cover (M3x8)
- BNC-to-RCA adapter

NOTE:



Apply a power cord that conforms to the AC voltage of the power socket and has been approved by and complies with the safety regulations of the particular country.

Touch and Power Connection Scenario

You can purchase digital signage system, including display and OPS module from Winmate. This section describes Winmate model combination, and includes some notes on each case.

Case I PC Mode

Purchase All-in-one (touch monitor and OPS module) from Winmate

Diagram:

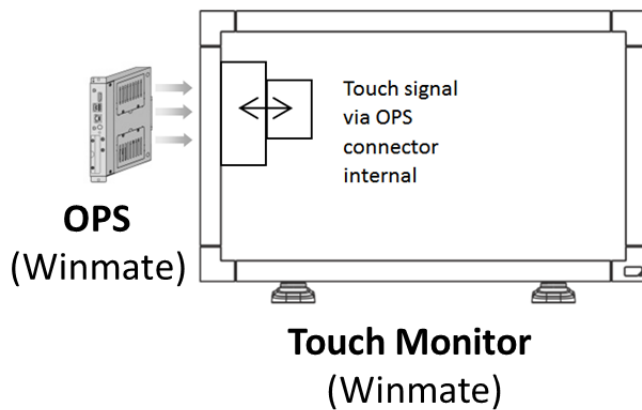

Note:

1. **USB touch:** in this case USB touch signal is set to go through internal OPS connector.
2. **Power:** when your signal comes from OPS module , make sure the power management settings default is "shut down"(refer to [page 10](#))

Case II Monitor Mode

Purchase only touch monitor from Winmate

Diagram:

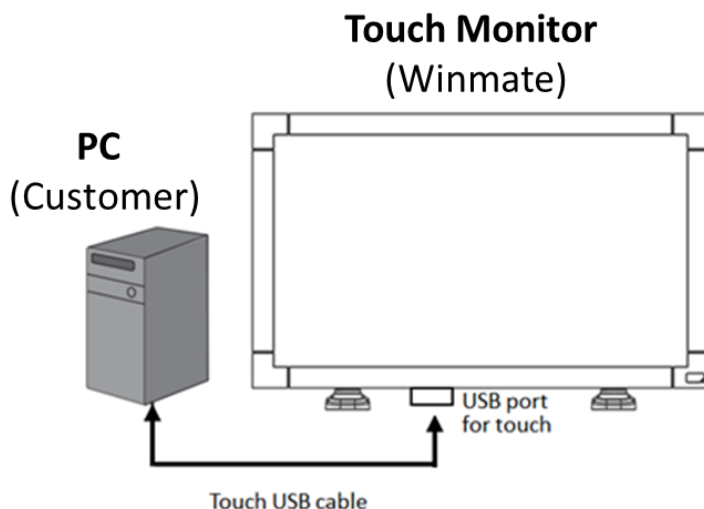

Note:

1. **USB touch:** in this case USB touch signal is set to go through external I/O side USB port.
2. You can use USB cable to connect the display USB port to the Panel PC USB port.
3. **Power:** requires signal from other PC source (standard settings).

Case III PC Mode

- Purchase only touch monitor from Winmate, and install OPS module at your side.
- Purchase touch monitor and OPS from Winmate, but in different time.

Diagram:

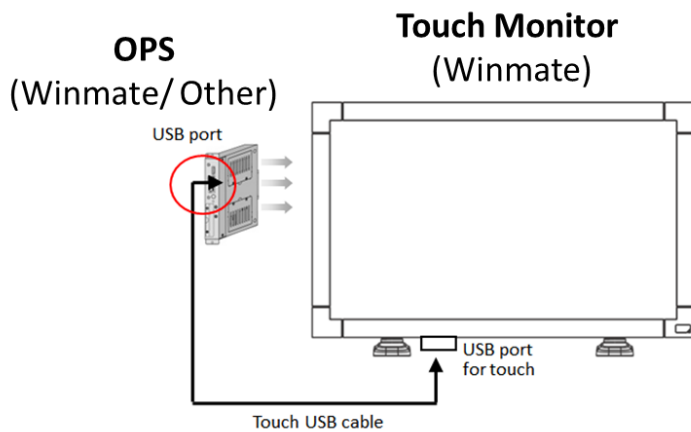

Note:

1. **USB touch:** in this case USB touch signal is set to go through external I/O side USB port.
2. You can use external USB cable to connect the display USB port and the OPS PC module USB port.
3. **Power:** when your signal comes from OPS module, make sure that the power management settings default is "shut down" (refer to the [page 10](#))



IMPORTANT:

Check your settings :

1. Power management setting is set on SHUT DOWN
2. Video signal is set on OPS

**If you purchase all-in-one solution from Winmate, power management setting is SHUT DOWN by default, and video signal default is OPS.*

OPS Module Installation

This section describes the OPS module installation procedures. OPS module slot is located on the rear side of the display.

Hardware installation steps:

1. Disconnect the AC power source from the Display, and make sure the system is powered OFF when you insert the OPS module.
2. Match the OPS module slot position with the Display.
3. Insert the OPS module to the slot on the rear side of the Display.
4. Fasten two Phillips M3x5 mm round head screws to fix OPS module to the Display.

Refer to the picture below for hardware installation illustration.

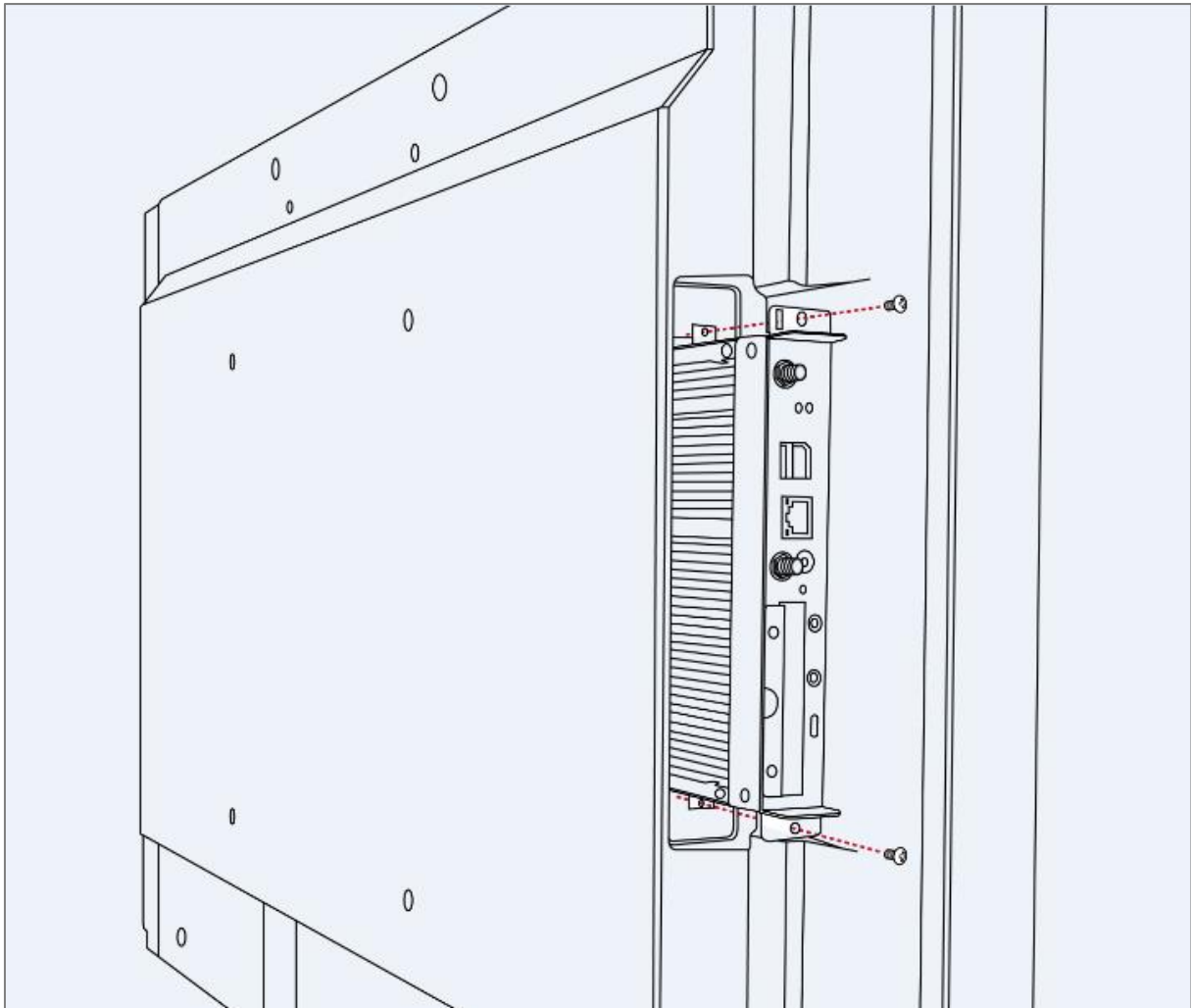

WARNING!

Always make sure the system is powered OFF when you install / remove hardware.

Display Input Signal Settings

Remote Control Layout

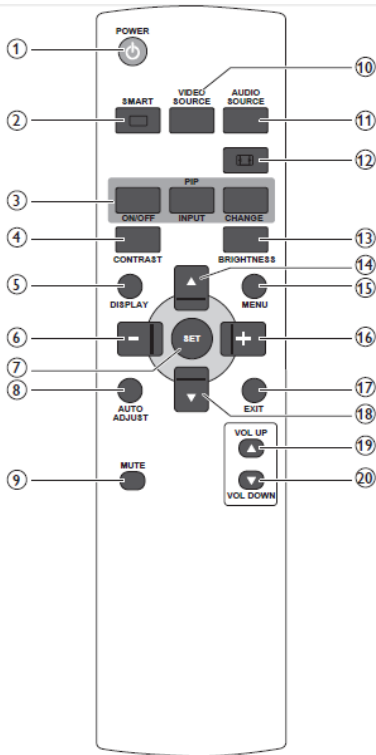

1 [POWER] button

Press to switch on the display from standby mode. Press again to turn it off and back into standby mode.

2 [SMART] button

Press to activate Smart Menu. Press [] or [] button to select menu options. Press [SET] button to confirm and exit the selection.

- Standard: Used for normal images (factory setting).
- Highbright: Used for moving image such as Video.
- sRGB: Used for text based images.

3 [PIP] (Picture-in-picture) button

[ON/OFF]: Turn PIP mode ON/OFF.

[INPUT]: Select the input signal for the sub-picture.

[CHANGE]: Toggle between.

4 [CONTRAST] button

Press to activate Contrast Menu. Press [] or [] button to adjust the value. Press [MENU] button to confirm and exit.

5 [DISPLAY] button

Press to turn on/off the information OSD displayed on the upper right corner of the screen.

6 [-] button

- Press to move the selection left in OSD menu.
- Press to decrease the value in OSD menu.
- Press to move the sub-picture left in PIP mode.

7 [SET] button

Please read these instructions carefully before using this product, and save this guide for future use.

Press to activate the setting inside the OSD menu.

8 [AUTO ADJUST] button

Press to run the Auto Adjust function.

NOTE: This button is functional for **VGA** input only.

9 [MUTE] button

Press to turn the mute function on/off.

10 [VIDEO SOURCE] button

Press to toggle Video Source Menu. Press [▲] or [▼] button to select one of the video sources among **HDMI, DVI-D, VGA, DVD / HD, VIDEO-S, VIDEO** or **OPS**. Press [SET] button to confirm and exit.

11 [AUDIO SOURCE] button

Press to toggle Audio Source Menu. Press [▲] or [▼] button to select one of the audio sources among **HDMI, AUDIO1, AUDIO2, or AUDIO3**. Press [SET] button to confirm and exit.

12 [PICTURE FORMAT] button

Press to switch screen aspect ratio.

- For PC signal: **FULL, NORMAL, CUSTOM** and **REAL**.
- For Video signal: **FULL, NORMAL, DYNAMIC, CUSTOM** and **REAL**.

13 [BRIGHTNESS] button

Press to toggle Brightness Menu. Press [+] or [-] button to adjust the value. Press [MENU] button to confirm and exit.

14 [▲] button

- Press to move the selection up in OSD menu.
- Press to move the sub-picture up in PIP mode.

15 [MENU] button

Press to turn the OSD menu on/off.

16 [+] button

- Press to move the selection right in OSD menu.
- Press to increase the value in OSD menu.
- Press to move the sub-picture right in PIP mode.

17 [EXIT] button

Press to turn back to the previous OSD menu.

18 [▼] button

- Press to move the selection down in OSD menu.
- Press to move the sub-picture down in PIP mode.

19 [VOL UP] button

Press to increase the audio output level.

20 [VOL DOWN] button

Press to decrease the audio output level.

Display Input Signal Settings

This section explains how to set video input signal on OPS.

1. Click **Video Source button (10)** on the remote control.
2. In the **VIDEO INPUT** drop-down menu select **OPS** channel.

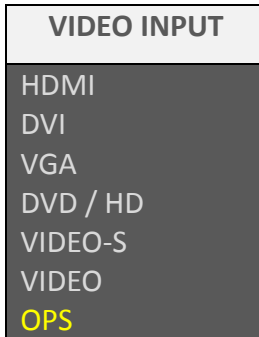

3. Click **SET button (7)** on the remote control to select OPS mode.
4. Turn ON the system power.

**If you purchase all-in-one solution (touch monitor and OPS) from Winmate, the default setting of VIDEO INPUT is OPS.*

Power Management Settings

This section explains what happens to touch monitor and OPS module when you power it ON/ OFF using the remote control.

Windows OS

Powering ON

To power ON the monitor with OPS module press power ON button on the remote control.

Powering ON process:

1. Remote control sends power ON signal to the monitor.
2. Monitor receives the signal from and trigger PC to power ON.
3. OPS module receives power ON signal and PC start booting (BIOS: AUTO ON)

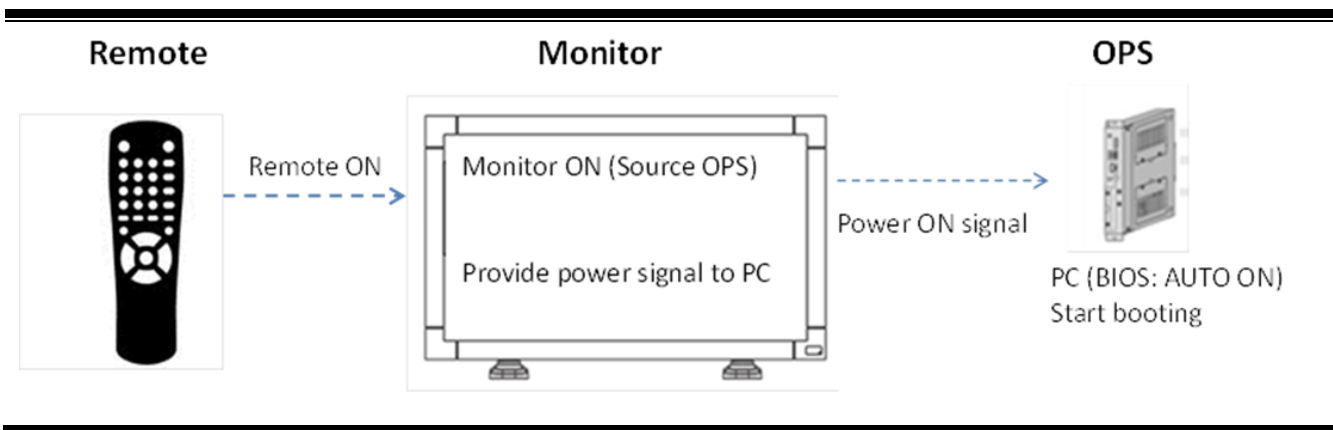

Powering OFF

To power OFF the monitor and OPS module, press power OFF button on the remote control. Check if power management settings of the PC is set as SHUT DOWN. In other case the OPS module might be working even if the monitor is OFF and switching OFF the power might cause OS system crash.

Powering OFF process:

1. Remote control sends power OFF signal to the monitor.
2. Monitor receives the signal and triggers PC to power OFF.
3. OPS module receives OFF signal. The power management setting of your PC should be set up on SHUT DOWN (refer to the section [“power management settings”](#) to check/ change settings).
4. After PC shuts down, the monitor is OFF.

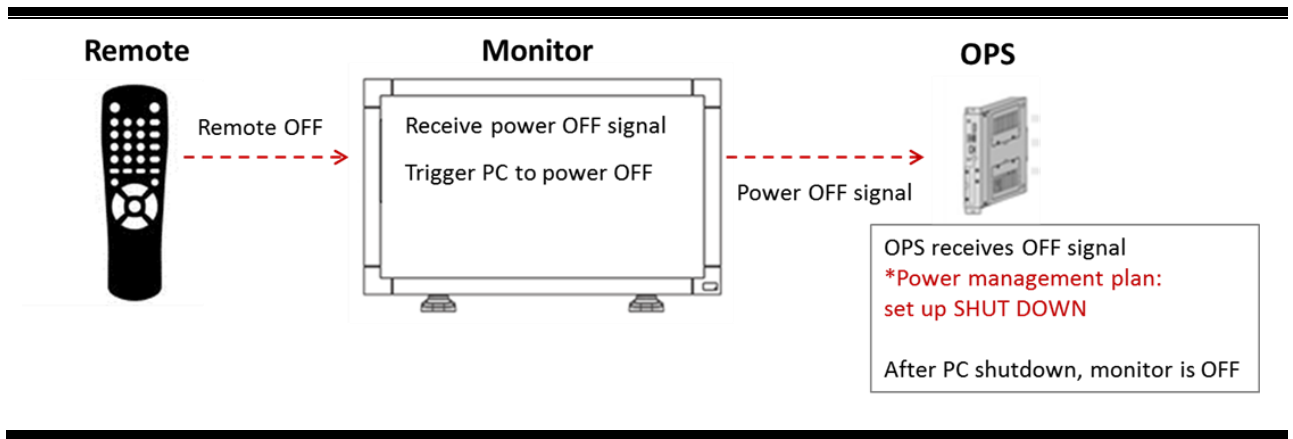

IMPORTANT:

If your power management plan is not set up as SHUT DOWN, the PC will not shut down. Switching OFF the power now might cause OS system crash.



IMPORTANT:

You need to TURN OFF the display in OPS Mode.

If you TURN OFF the display in HDMI, DVI, VGA, DVD or VIEDE Modes, it won't influence OPS Module power status.

Power Management Settings

In OPS mode the power control of the OPS module is influenced by display's OSD or remote control. Pressing the power button on the OSD panel or remote control will control the OPS Module at the same time (default setting is "shut down"). If you want to change power management settings follow the steps below.

1. Go to  > Control Panel > System and Security > select **Power Options**

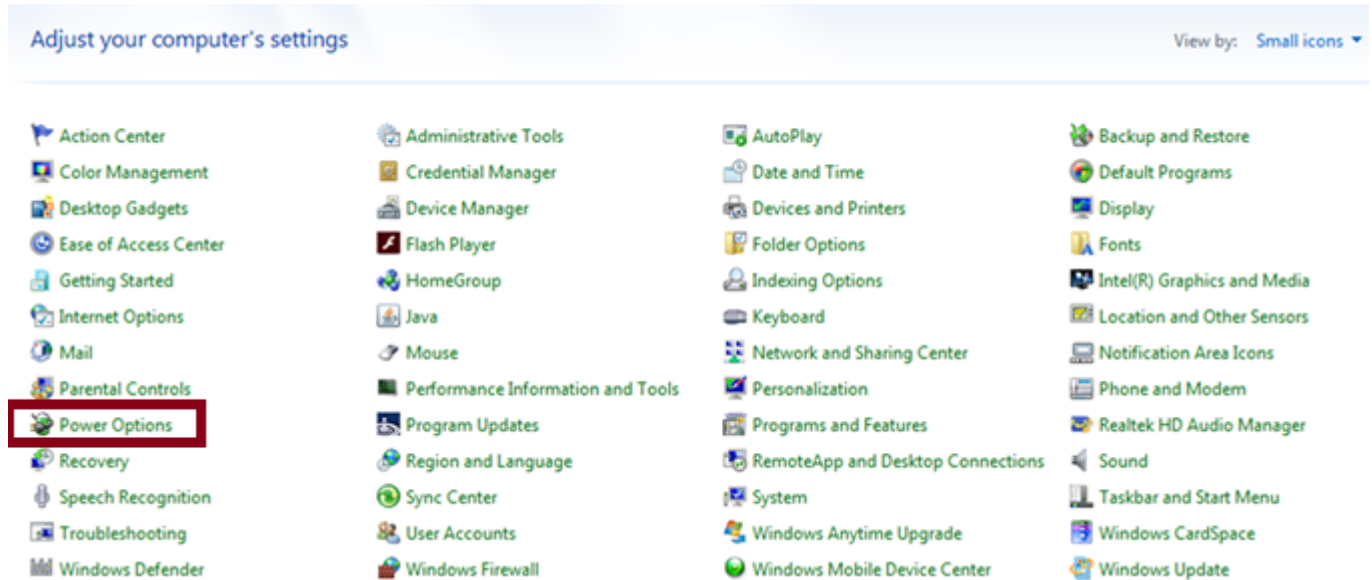

2. In the menu on the top left side of desktop select **Choose what the power buttons do**

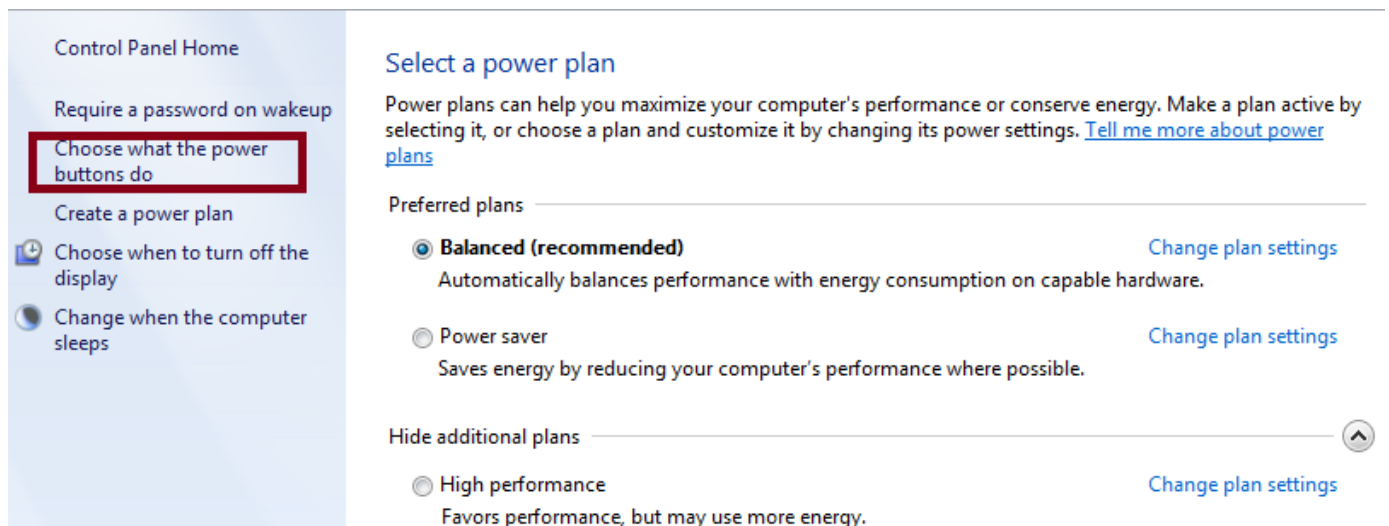

3. In the Power and sleep button settings drop-down menu, choose “When I press the power button: **Shut down**.”

Define power buttons and turn on password protection

Choose the power settings that you want for your computer. The changes you make to the settings on this page apply to all of your power plans.

Power and sleep button settings



4. Save the changes

Define power buttons and turn on password protection

Choose the power settings that you want for your computer. The changes you make to the settings on this page apply to all of your power plans.

Power and sleep button settings

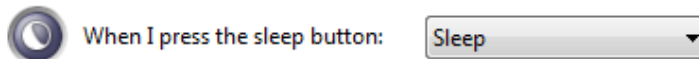
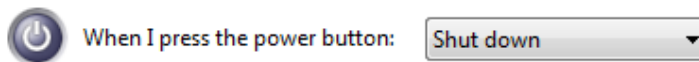

Password protection on wakeup

Change settings that are currently unavailable

- Require a password (recommended)

When your computer wakes from sleep, no one can access your data without entering the correct password to unlock the computer. [Create or change your user account password](#)

- Don't require a password

When your computer wakes from sleep, anyone can access your data because the computer isn't locked.



Android OS

If your system is running on Android there is no need to adjust power management settings. Follow the original default factory settings.

Power ON:

Powering ON diagram for OPS running on Android OS showed on the picture below.

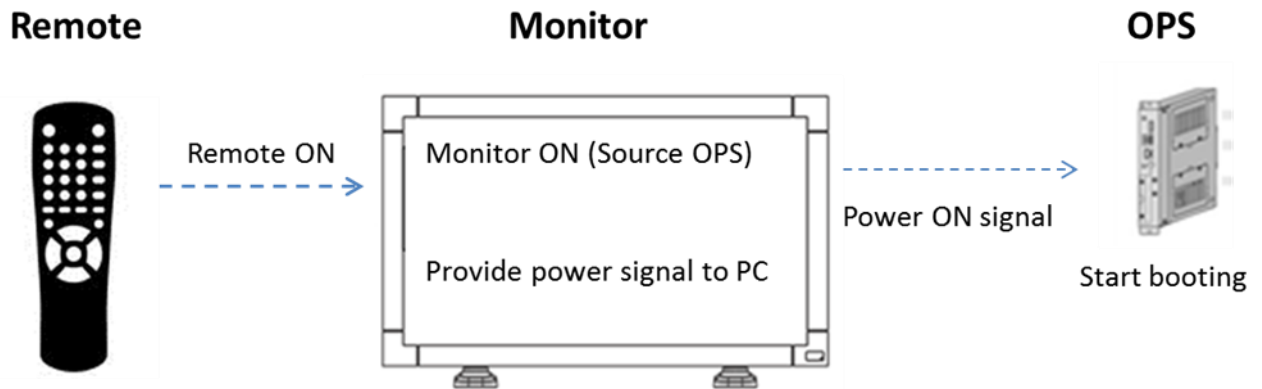

Power OFF:

Powering OFF diagram for OPS running on Android OS showed on the picture below.

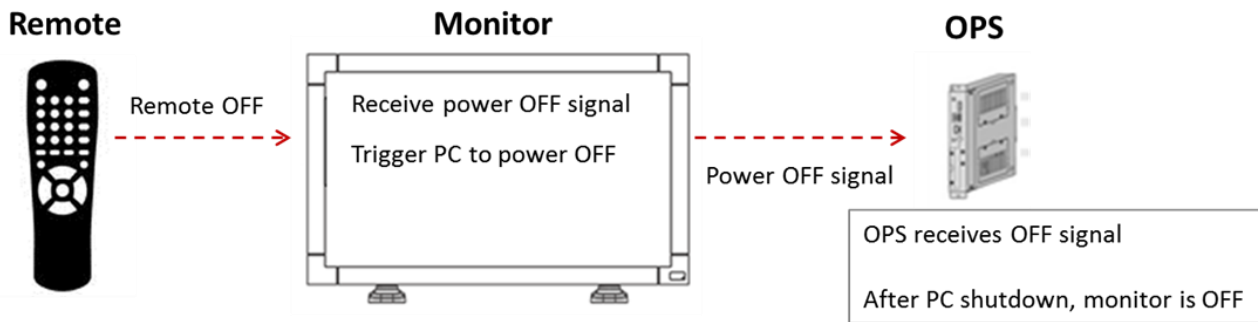



Winmate Inc.

9F, No.111-6, Shing-De Rd., San-Chung Dist.,
Taipei 241, Taiwan, R.O.C

Tel: 886-2-8511-0288

Fax: 886-2-8511-0211

Email: sales@winmate.com.tw

Official website: <http://www.winmate.com.tw>
